

This article was downloaded by:

On: 25 January 2011

Access details: *Access Details: Free Access*

Publisher *Taylor & Francis*

Informa Ltd Registered in England and Wales Registered Number: 1072954 Registered office: Mortimer House, 37-41 Mortimer Street, London W1T 3JH, UK



Journal of Macromolecular Science, Part A

Publication details, including instructions for authors and subscription information:

<http://www.informaworld.com/smpp/title~content=t713597274>

The Color of Fabrics: Effect of Yarn Separation

George Goldfinger^a; Kathy A. Paige^{ab}

^a North Carolina State University at Raleigh School of Textiles, Raleigh, North Carolina ^b Now Kathy Paige Mullis,

To cite this Article Goldfinger, George and Paige, Kathy A.(1977) 'The Color of Fabrics: Effect of Yarn Separation', Journal of Macromolecular Science, Part A, 11: 3, 667 – 677

To link to this Article: DOI: 10.1080/00222337708061293

URL: <http://dx.doi.org/10.1080/00222337708061293>

PLEASE SCROLL DOWN FOR ARTICLE

Full terms and conditions of use: <http://www.informaworld.com/terms-and-conditions-of-access.pdf>

This article may be used for research, teaching and private study purposes. Any substantial or systematic reproduction, re-distribution, re-selling, loan or sub-licensing, systematic supply or distribution in any form to anyone is expressly forbidden.

The publisher does not give any warranty express or implied or make any representation that the contents will be complete or accurate or up to date. The accuracy of any instructions, formulae and drug doses should be independently verified with primary sources. The publisher shall not be liable for any loss, actions, claims, proceedings, demand or costs or damages whatsoever or howsoever caused arising directly or indirectly in connection with or arising out of the use of this material.

The Color of Fabrics: Effect of Yarn Separation

GEORGE GOLDFINGER and KATHY A. PAIGE*

North Carolina State University at Raleigh
School of Textiles
Raleigh, North Carolina 27607

ABSTRACT

Earlier calculations permitting the prediction of the color of fabrics from the optical and geometric properties of the substrate and the continuous medium have been extended to account for the effect of yarn separation. The reflectance of low reflectance yarn increases while that of high reflectance yarn decreases as the separation of yarn decreases.

INTRODUCTION

In earlier papers [1-4], a model was proposed with which the effect of the dye concentration, the spectral properties of the dye-fiber system, and the ratio of refractive indexes of the fiber to the continuous medium on the color of the fabric can be predicted. This model assumed that the fibers or yarns constituting the fabric are so far removed from each other that the lightpaths of radiation reflected or refracted by one fiber is not affected by the neighboring

*Now Kathy Paige Mullis.

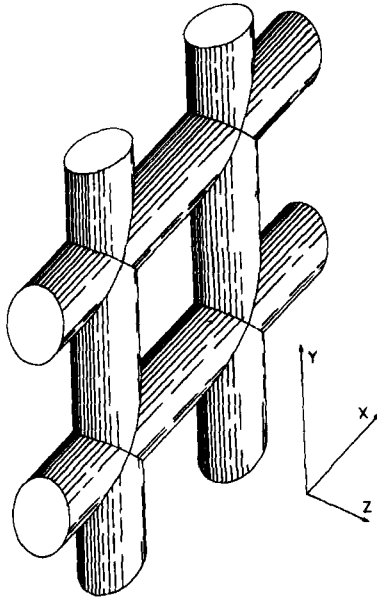

FIG. 1. Representation of the model of the fabric.

fibers. Although this assumption is manifestly an oversimplification, the basic validity of the model could be demonstrated by several experimental studies [5-10].

This model is being extended to consider the effect on the color of the fabric of the distance between fibers and the angle of illumination and of viewing.

THE MODEL

It is assumed that the fabric is composed of an array of optically homogeneous cylinders of equal diameters lying in one plane which consists of two portions. In each portion the fibers are parallel but the two portions are at right angle to each other. The entire array lies in the plane x - y (Fig. 1), and consequently the fibers parallel to x interpenetrate those parallel to y .

In Fig. 2 two of those cylinders are shown. The broken arrow indicates one beam of light which is reflected first by one fiber onto the adjacent fiber and then by this second fiber. Two characteristic

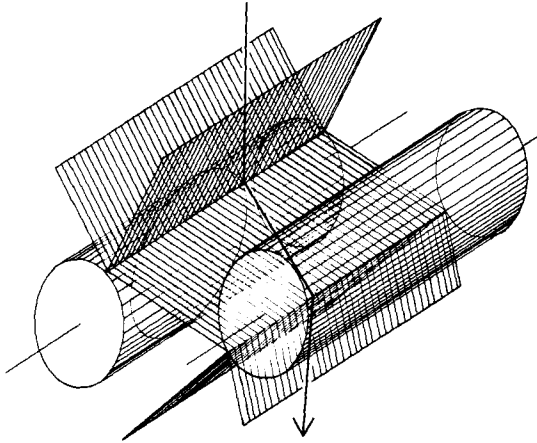

FIG. 2. Two fibers. The planes in which a light beam travels and the planes normal to the points of illumination of the two fibers.

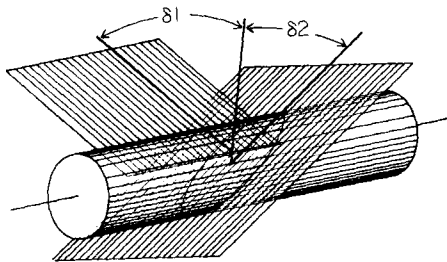

FIG. 3. The planes in which the component angles of the illuminating beam lie.

angles δ_1 and δ_2 define the direction of the incident beam (Fig. 3). As can be readily seen from Fig. 2, the location, if any, where the beam reflected (or refracted) from the first fiber impinges on the second one is defined by δ_1 and the distance between the fibers.

δ_2 defines the tilt of the plane in which the path of the refracted beam lies indicated by the ellipses shown in Figs. 2 and 3. From both angles δ_1 and δ_2 can be calculated the angle of incidence of the beam in respect to the plane tangent to the fiber at the point of

incidence. It controls, together with the ratio of the refractive indexes of the fiber to that of the continuous medium the ratio of reflection to refraction at the fiber interfaces.

CALCULATIONS

It is δ_1 , as can be seen in Fig. 2, the component of the angle of illumination in the plane perpendicular to the axes of the fibers used as reference, to a line normal to that plane, which determines whether the reflected or refracted beam will impinge on the adjacent fiber or be reflected toward the light source or away from it.

A typical (partial) pattern of reflection and refraction is shown in Fig. 4. In Fig. 5 a light beam reflected from the first fiber onto the second one and back toward the light source is traced. The independent variables from which all reflection-refraction patterns are calculated are δ_1 , the above mentioned component of the incident beam (setting the other component, δ_2 equal to zero), the distance of the fibers S expressed in terms of the fiber radius, and the distance d_1 (in terms of fiber radius) from the fiber axis at which the light beam crosses the plane perpendicular to the incident beam and crosses the fiber axis.

From these quantities θ_1 the component of the angle of incidence, is

$$\theta_1 = \arcsin d_1 \quad (1)$$

Whether the beam reflected will or will not impinge on the adjacent

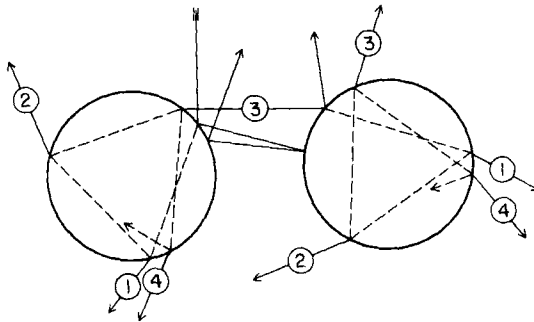

FIG. 4. A partial reflection and refraction pattern of one light beam and two fibers.

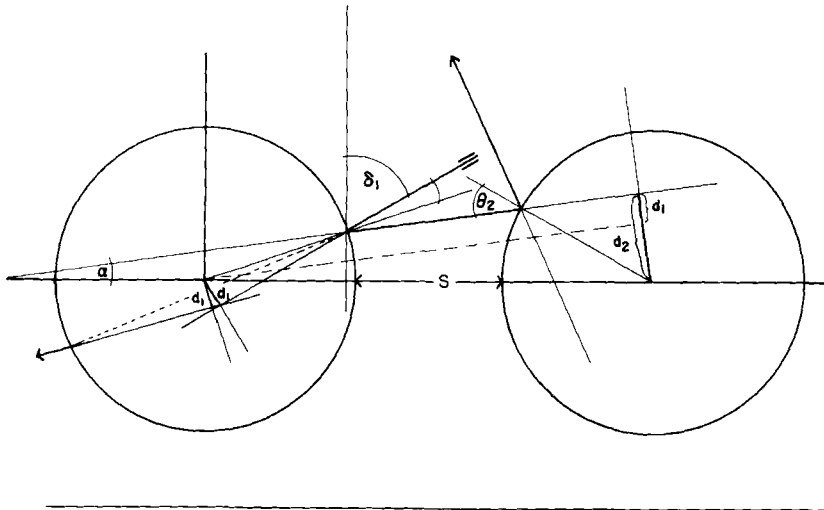

FIG. 5. Calculation of the point of incidence of a light beam, in this case reflected, on a second fiber. If d_2 is larger than 1, then the second fiber does not interfere with the light path.

fiber depends on the value of d_2 . If d_2 is larger than 1 then the beam does not impinge. The value of d_2 is

$$d_2 = (2 + S) \sin \alpha + d_1 \tag{2}$$

and

$$\alpha = 90 - (\delta_1 + 2\theta_1) \tag{3}$$

If d_2 is equal to or smaller than 1, then the angle of incidence θ_2 on the second fiber is of interest, and its value is

$$\theta_2 = \arcsin d_2 \tag{4}$$

If the distance between the fibers, S is larger than zero and the angle of incidence δ_1 fulfills the condition

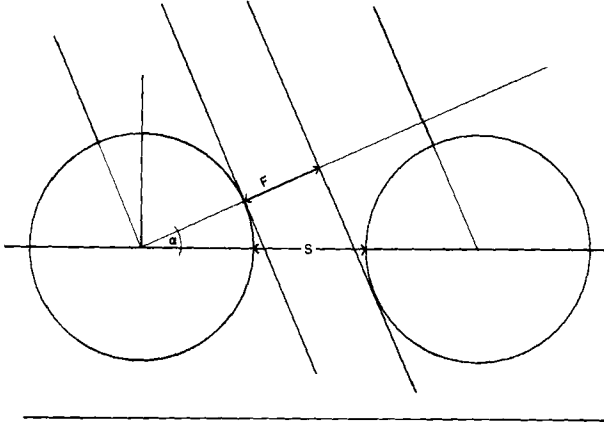

FIG. 6. Portion of the light bundle which passes between the fibers of one layer of fabric.

$$\delta_1 < \arccos [2/(2 + S)] \quad (5)$$

then a portion of the incident radiation continues away from the light-source unimpeded by the fibers. This portion F (Fig. 6) is

$$F = (2 + S) \cos \delta_1 - 2 \quad (6)$$

That portion of the light bundle of the thickness $(2 + S)$ which does not continue unimpeded of course impinges on the fibers and is accounted for by the reflection-refraction calculations.

The angles of refraction are calculated from Snell's law. The angle of the refracted beam in respect to the illuminating beam is

$$\text{Angle} = \delta_1 - 2[\theta_1 - n(90 - \rho)] \quad (7)$$

where n is the order of refraction as seen in Fig. 7, for example, and ρ is the angle of refraction from

$$\sin \theta_1 / \sin \rho_1 = m \quad (8)$$

$$\sin \theta_1 = d_1 \quad (9)$$

$$\rho_1 = \arcsin (d_1/m) \quad (10)$$

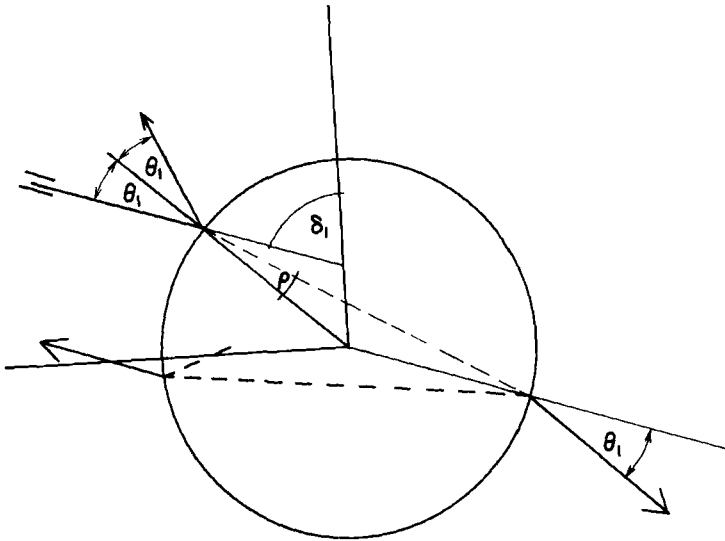

FIG. 7. Angles of multiple refracted beam.

where m is the ratio of the refractive index of the fiber to that of the continuous medium.

It can readily be seen (Fig. 4) that by reflections alone, a light beam can only reach fibers adjacent to the one upon which it originally impinges. However, light refracted by the fibers can reach their neighbors which can well be far removed from the original fiber and by repetition of this process can, intensity permitting, reach to any distance within the plane.

For purposes of calculation each refracted element of light is treated as one original beam, its intensity properly adjusted. This is a process easily carried out by iteration in a computer program to any desired limit of residual light intensity.

So far the angle of incidence has been defined in terms of its components in the two planes: parallel and perpendicular to the fiber axis. For purposes of reflection-refraction calculations, however, an angle A has to be calculated, which is defined by the light beam u and the extension of the fiber radius at the point at which that beam impinges on the fiber surface, the line q in Fig. 8.

It is clear from Fig. 7 that

$$A = \arctan Z \tag{11}$$

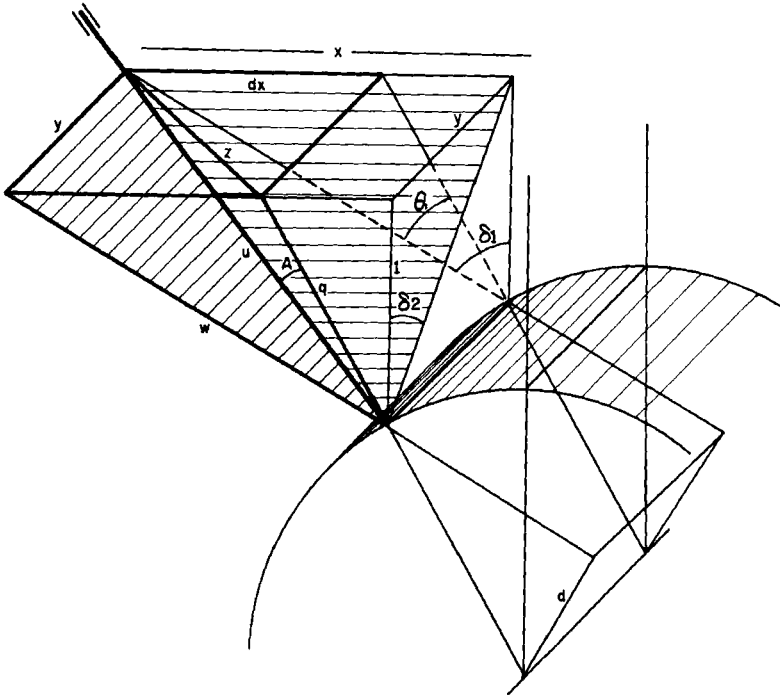

FIG. 8. Calculation of the angle of incidence A from its components δ_1 and δ_2 and the point of incidence on the fiber in terms of the quantity d .

where

$$Z = \sqrt{y^2 + (ds)^2} \quad (12)$$

and

$$y = \tan \delta_2 \quad (13)$$

and

$$dx = \tan (\delta_1 - \theta_1) - \tan \delta_1 \quad (14)$$

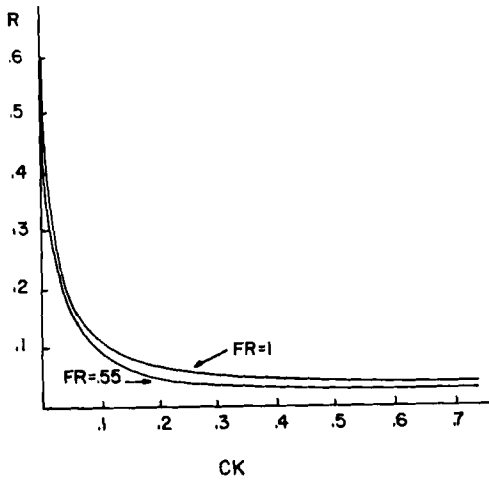

FIG. 9. Reflectance R as a function of CK, the product of the coefficient of absorption of the dye-fiber system, the dye concentration, and the fiber radius. Fr is the fraction of surface covered by one layer of fabric.

The components of the reflected and refracted beams in respect to the plane of the fabric could be calculated. However symmetry suggests that the angles obtained when setting $\delta_2 = 0$ will be correct in the space outside the plane perpendicular to the fabric and to the axis of the reference fiber.

Finally the length of the light path has to be calculated for all values of δ_2 . When that angle is larger than zero, then the plane in which the refracted beam travels is elliptical. The short axis of this ellipse is equal to the diameter of the fiber and its long axis is

$$LA = 2/\cos \delta_2$$

We can assume that the light path will be in the same proportion to that in the circular cross section as the ratio of the circumference of the elliptical to the circular cross section.

Thus the light paths will have to be multiplied by $1/\cos \delta_2$ (see Eq. (10) in reference [1]).

$$lp = \frac{(\cos \delta_2 + 1) (m^2 - d^2)^{1/2}}{m \cos \delta_2} \tag{16}$$

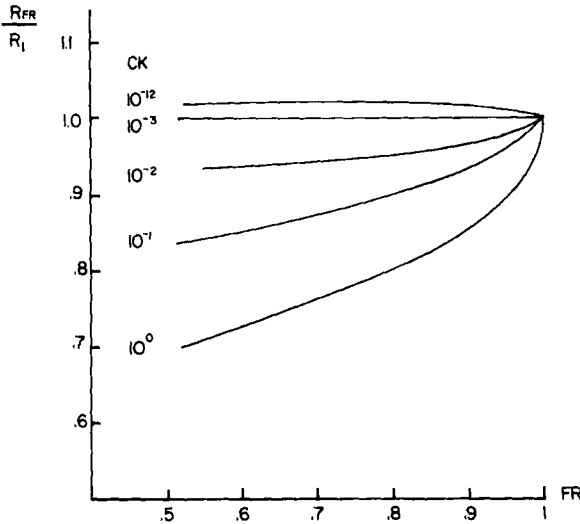

FIG. 10. Reflectance expressed as ratio of the observed reflectance to the reflectance of a fabric completely covering the surfaces.

RESULTS

The very high cost of the computer calculations limited our evaluation of all the possible angles of illumination and viewing and fiber configurations.

Only random illumination in the y - z plane with the fiber in the x direction (Fig. 1), equal spacing of the fibers in the x and y directions and perfectly scattered viewing was completely evaluated for fiber separation resulting in complete to 55% coverage by one layer of fabric.

In Fig. 9 the effect of complete and 55% coverage is shown on reflectance for various values of CK (the product of the coefficient of absorption of the dye-fiber system, the dye concentration in the fiber, and the fiber radius [1] for a refractive index ratio $m = 1.6$).

Figure 10 shows reflectance values expressed in terms of ratio of the reflectance of any given fraction of surface covered to the reflectance at complete coverage (distance between fibers = 0) for $CK = 10$, black to $CK = 10^{-12}$, white. It can be seen, that a pile of black fabric becomes significantly darker as the structure of the fabric is loosened up, while the same change in the structure of a white fabric increases, though only marginally the reflectance. Experimental results, to be published shortly, bear out this prediction.

REFERENCES

- [1] E. Hope Allen and G. Goldfinger, J. Appl. Polym. Sci., 16, 2973 (1972).
- [2] E. Hope Allen and G. Goldfinger, J. Appl. Polym. Sci., 17, 1627 (1973).
- [3] G. Goldfinger, Colourage, 21, 25 (Sept. 1974).
- [4] G. Goldfinger, J. Polym. Sci. B, 13, 23 (1975).
- [5] E. Hope Allen, D. L. Faulkner, G. Goldfinger and R. McGregor, J. Polym. Sci. B, 10, 203 (1972).
- [6] E. Hope Allen, D. L. Faulkner, G. Goldfinger, and R. McGregor, J. Appl. Polym. Sci., 17, 873 (1973).
- [7] G. Goldfinger, O. C. Lau, and R. McGregor, J. Polym. Sci. B, 11, 481 (1973).
- [8] G. Goldfinger and L. Stafford, J. Polym. Sci. B, 11, 701 (1973).
- [9] G. Goldfinger, K. C. Lau, and R. McGregor, J. Appl. Polym. Sci., 18, 1741 (1974).
- [10] G. Goldfinger and K. A. Paige, Colourage, 22, 23 (Jan. 1975).

Accepted by editor September 15, 1976

Received for publication October 18, 1976